



alumínio
ALUMÍNIO

PERFIS COR **CEREJEIRA REAL**

poliformas 
ALUMÍNIOS E FERRAGENS



Efeito sublimado *Cerejeira Real*

**DEVIDO ÀS NUANCES DO PERFIL DE ALUMÍNIO, O MESMO
PODERÁ TER VARIAÇÕES DE TONALIDADES.**

**FALE COM NOSSOS VENDEDORES PARA DEMAIS
INFORMAÇÕES.**

O acabamento amadeirado é um processo de beneficiamento que proporciona um efeito semelhante ao da madeira em perfis e chapas de alumínio. O processo é feito através da técnica de sublimação, um dos processos mais modernos existentes hoje no mercado mundial e um dos mais eficientes, e que tem como seu diferencial uma maior durabilidade, melhor cobertura e aspecto mais próximo ao da madeira.

Sublimação

É a aplicação de uma tinta especial na base, após essa aplicação, os perfis são revestidos com um filme de sublimação, com efeito madeira no acabamento desejado. Com esta técnica é possível fixar o efeito madeira em todas as cavidades através da passagem de partículas de tinta existentes no filme, após o perfil ser revestido, é executada a selagem na mesa de vácuo, e posteriormente levado ao forno a 270° C.

A alta temperatura faz com que os veios e coloração existentes no filme sejam transferidos para os perfis, conforme a ilustração abaixo.

DECORAL • PROCESSO • HEAT TRANSFER

Processo físico onde a tinta (partículas) quando atingem a uma determinada temperatura passam diretamente do estado sólido para estado gasoso.

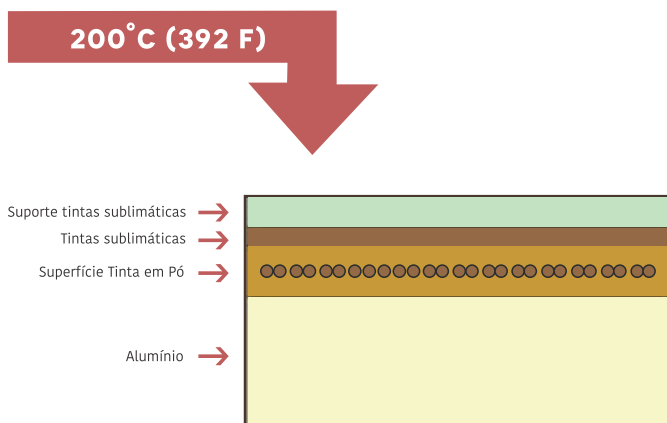
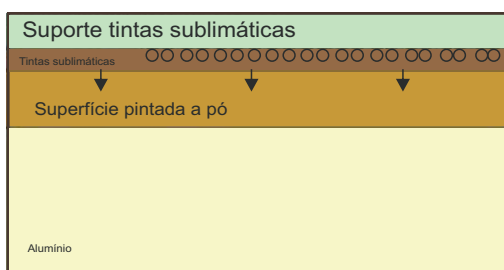



ÍNDICE

| Código | / | Página | Código | / | Página |
|---------------|----------|---------------|---------------|----------|---------------|
| LG-016 | | 05 | PC-003 | | 09 |
| LG-026 | | 05 | PC-004 | | 09 |
| LG-042 | | 05 | PC-010 | | 09 |
| LG-055 | | 05 | LB-036 | | 10 |
| LG-056 | | 06 | LB-075 | | 10 |
| LG-059 | | 06 | LB-100 | | 10 |
| LG-158 | | 06 | LB-165 | | 10 |
| 30-023 | | 06 | TUB-4501 | | 11 |
| 30-034 | | 07 | MA-050 | | 11 |
| 30-082 | | 07 | MP-4302 | | 11 |
| 42-012 | | 07 | CT-005 | | 11 |
| 42-014 | | 07 | CT-007 | | 12 |
| 42-032 | | 08 | CT-016 | | 12 |
| 42-176 | | 08 | MX-119 | | 13 |
| BG-010 | | 08 | MX-128 | | 13 |
| BG-037 | | 08 | MX-129 | | 13 |
| CG-021 | | 09 | MX-391 | | 13 |

LG-016

COMPLEMENTO DA FOLHA / BATENTE CJR

Peso (kg/m) 0,34 0

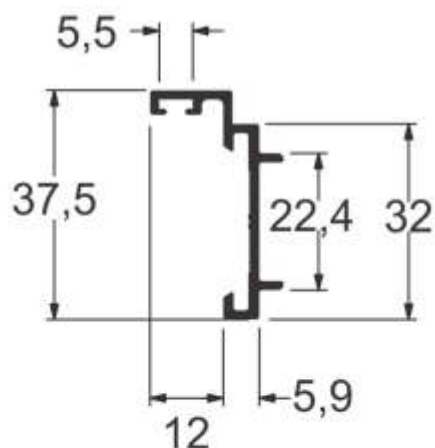

LG-026

BAGUETE CEREJEIRA REAL

Peso (kg/m) 0,165

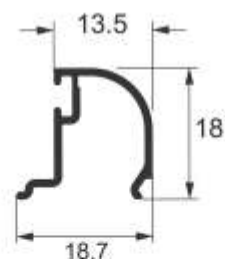

LG-042

MONTANTE DA FOLHA PORTA DE GIRO CJR

Peso (kg/m) 1,190

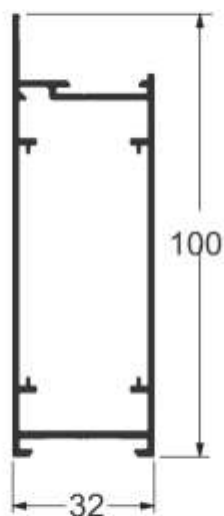

LG-055

TRAVESSA INTERMEDIARIA DA FOLHA CJR

Peso (kg/m) 0,760

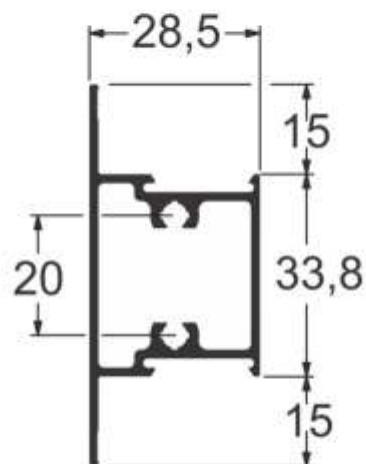

LG-056

MARCO LATERAL / BATE. PORTA GIRO CJR

Peso (kg/m) 0,655

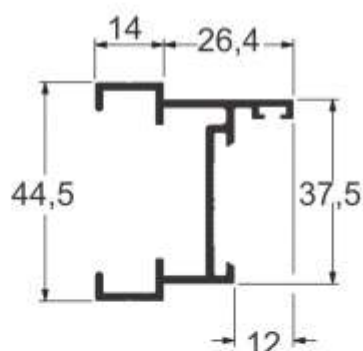

LG-059

PERFIL BAQUETE 17,5x18mm CRJ

Peso (kg/m) 0,175

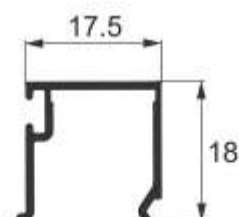

LG-158

MARCO LATERA LISO 3 FOLHAS CRJ

Peso (kg/m) 0,880



30-023

MARCO LATERAL DA PORTA CRJ

Peso (kg/m) 0,573

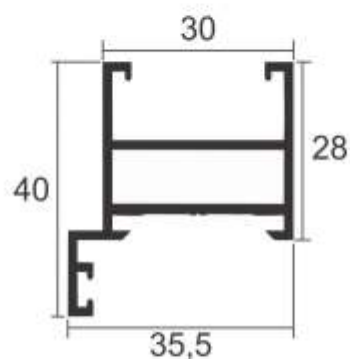

30-034

MARCO LATERAL - BATENTE CRJ

Peso (kg/m) 0,276

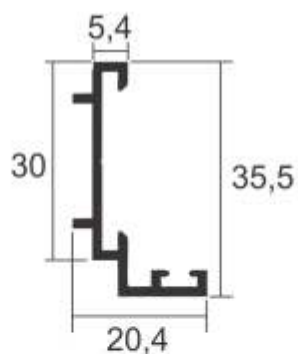

30-082

MONTANTE PARA PORTA DE GIRO 100MM CRJ

Peso (kg/m) 1,184

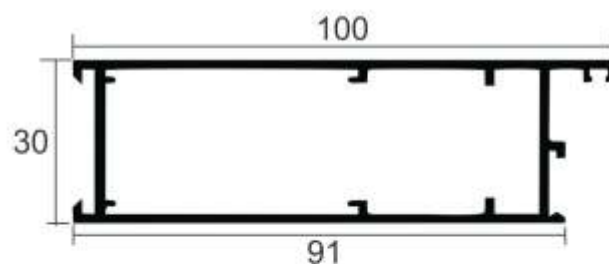

42-012

MARCO PORTA DE GIRO CRJ

Peso (kg/m) 0,897

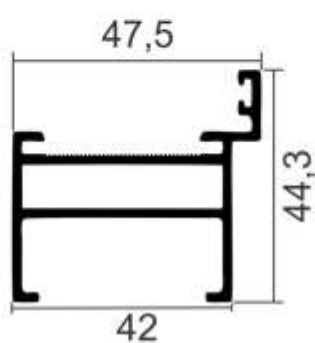

42-014

MARCO LATERAL - MATA JUNTA CRJ

Peso (kg/m) 0,392

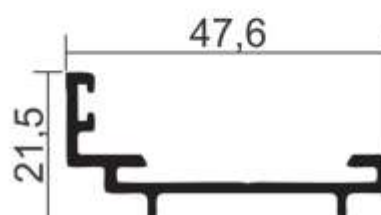

42-032

MONTANTE DA FOLHA 100MM C/ BAGUETE CRJ

Peso (kg/m) 1,422

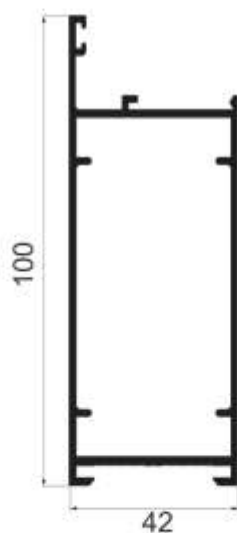

42-176

MONT. DA FOLHA 150MM SEM BAGUETE CRJ

Peso (kg/m) 1,948

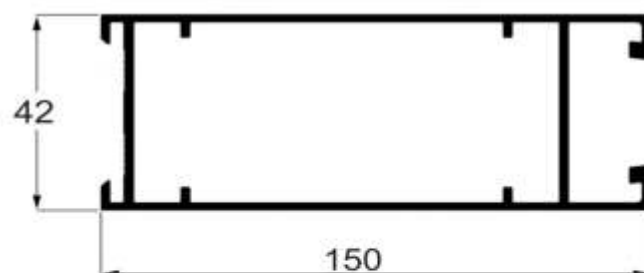

BG-010

BAGUETE 15 X 11,7 MM CRJ

Peso (kg/m) 0,123

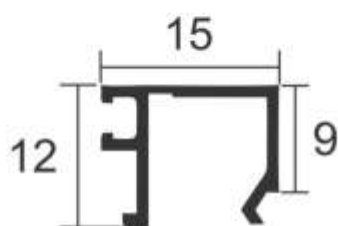

BG-037

BAGUETE 27 X 19,5MM CRJ

Peso (kg/m) 0,200

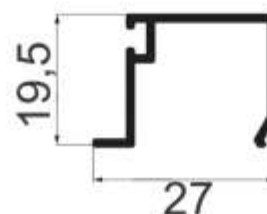

CG-021

TUBO RETANGULAR 25 x 14MM CRJ

Peso (kg/m) 0,345

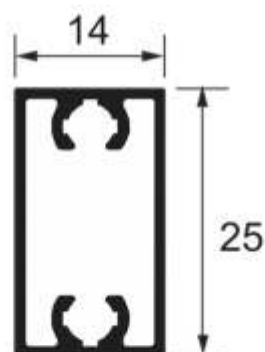

PC-003

TUBO RETANGULAR 76.2 x 38.2 CRJ

Peso (kg/m) 0,960

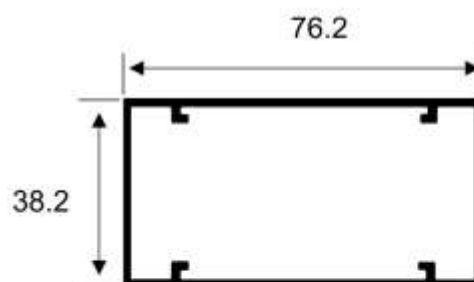

PC-004

TUBO RETANGULAR 50.8 x 38.1 CRJ

Peso (kg/m) 0,634

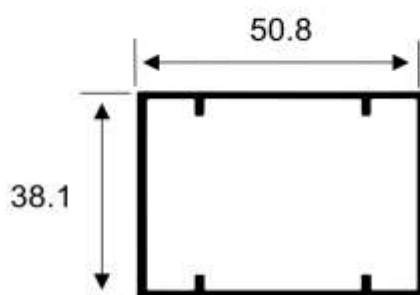

PC-010

MONTANTE DA FOLHA PORTÃO CRJ

Peso (kg/m) 0,930

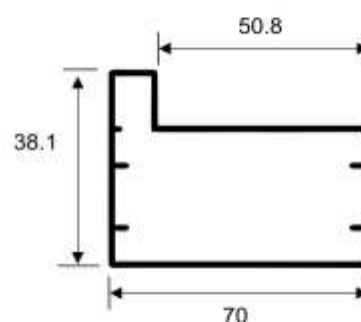

LB-036

LAMBRIL LISO 168MM (Y-335) CR

Peso (kg/m) 0,660

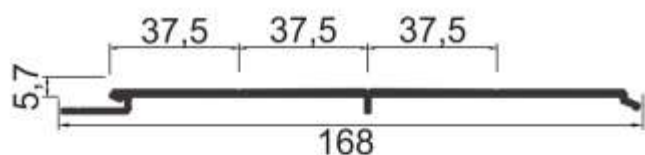

LB-075

LAMBRIL RIPADO 155MM CRJ

Peso (kg/m) 0,981

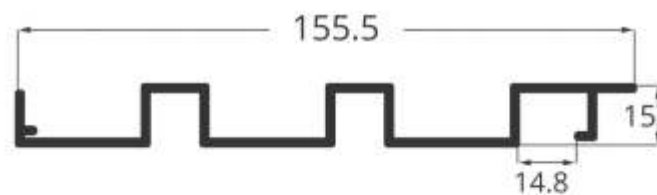

LB-100

AMBRIL DUPLO 100MM CRJ

Peso (kg/m) 0,698

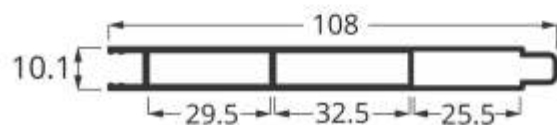

LB-165

LAMBRIL DUPLO 165MM CRJ

Peso (kg/m) 1,495

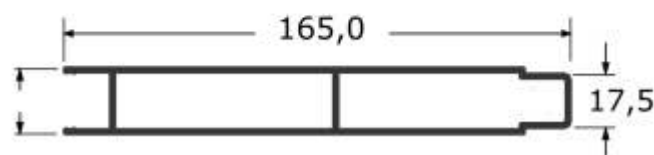

TUB-4501

TUBO RETANGULAR 25.4 X 12.7 MM CRJ

Peso (kg/m) 0,234

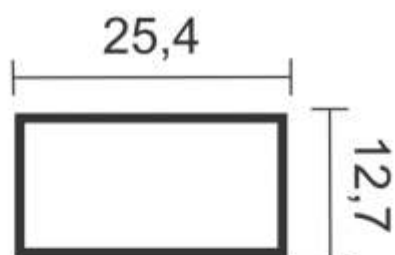

MA-050

ARREMATE - MOLDURA 60MM CONVEXO CRJ

Peso (kg/m) 0,286

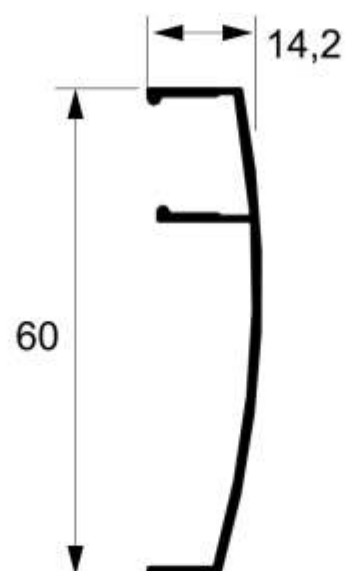

MP-4302

ARREMATE - MOLDURA 47,2MM CONVEXO CRJ

Peso (kg/m) 0,250

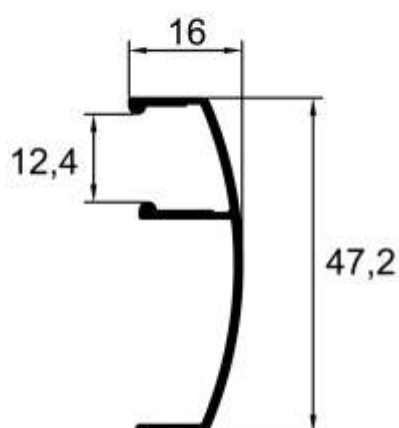

CT-005

CANTONEIRA DE 15.8 x 15.8 / 1MM CRJ

Peso (kg/m) 0,109



CT-007

CANTONEIRA 19.05 x 19.05 / 1MM CRJ

Peso (kg/m) 0,149

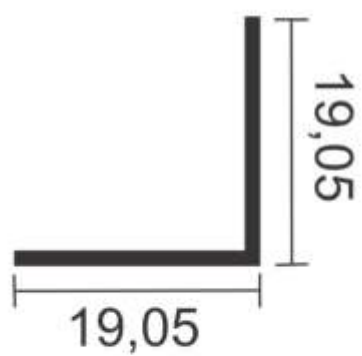

CT-016

CANTONEIRA 25.4 x 25.4 / 1.2MM CRJ

Peso (kg/m) 0,200

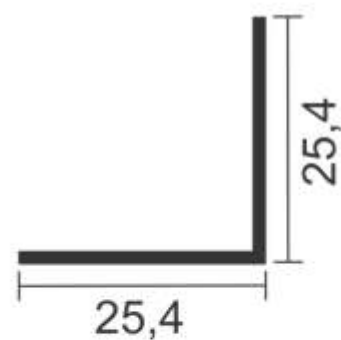

Perfis muxarabi

Cerejeira Real

MX-391

MONTANTE 60.5 MM MUXARABI CRJ

Peso (kg/m) 0,657

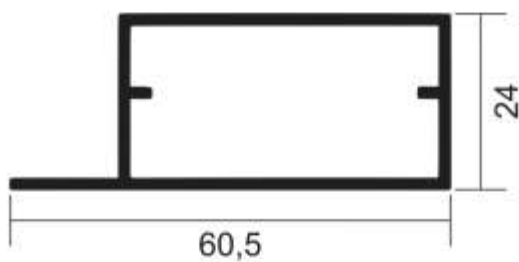

MX-119

CLICK C/ ENCAIXE MX-128 E MX-129 CRJ

Peso (kg/m) 0,105

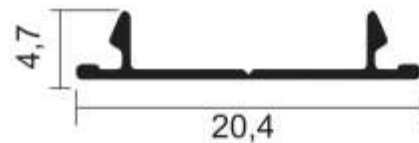

MX-128

PERFIL U 23 X 10 C/ ENC. CLICK CRJ

Peso (kg/m) 0,152

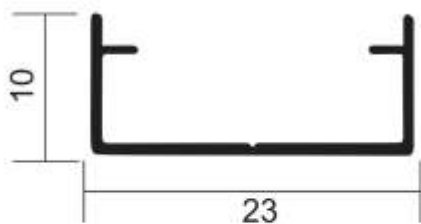

MX-129

PERFIL U 23 X 15 C/ ENC. CLICK CRJ

Peso (kg/m) 0,178

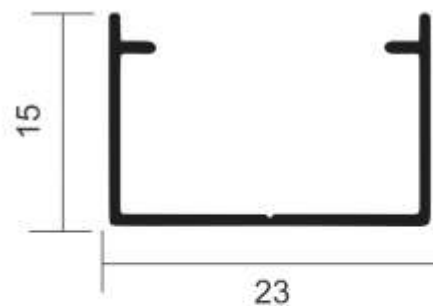



62 3247-3610
@poliformas.go
www.poliformas.com.br