

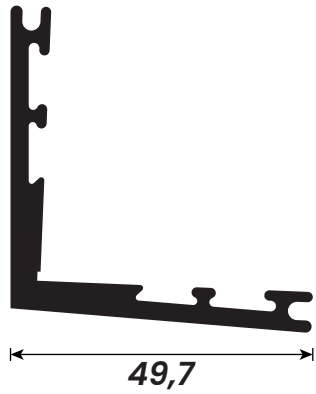

ALUMÍNIO
ALUMÍNIO
PERFIS DIVERSOS **ESQUADRIAS**

poliformas 
ALUMÍNIOS E FERRAGENS

CÓDIGO	PESO (kg/m)	DESCRIÇÃO	PÁGINA
CL-006	1,131 kg	Cantoneira (macho) 52mm	01
CL-011	0,333 kg	Cunha para CL-006 50mm	01
CL-044	1,050 kg	Cantoneira (macho) 64mm	01
CL-010	0,422 kg	Cunha para CL-044 60mm	01
AL-02	0,185 kg	Trilho Inferior Único de Embutir (Macarrão-Filete) Natural	01
AL-20	0,224kg	Trilho inferior com abas e encaixe	01
CM-200	0,170 kg	Contra-Marco	02
ACP-008	0,078 kg	Faixa de Arremate para Carpete 28×2.2mm	02
ACP-006	0,130kg	Cantoneira para Pisos e Escadas 34×14mm	02
ME-013	0,275 kg	Arremate de Piso	02
MP-347	0,198kg	Arremate – Moldura 37mm	02
MN-014	0,210 kg	Arremate – Moldura 42mm	02
MP-4302	0,250 kg	Arremate – Moldura 47,2mm Convexo	03
MA-050	0,286 kg	Arremate – Moldura 60mm Convexo	03



Cod. Poliformas	Peso (kg/m)
CL-006	1,131

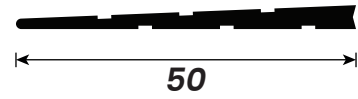

Cod. Poliformas	Peso (kg/m)
CL-011	0,333

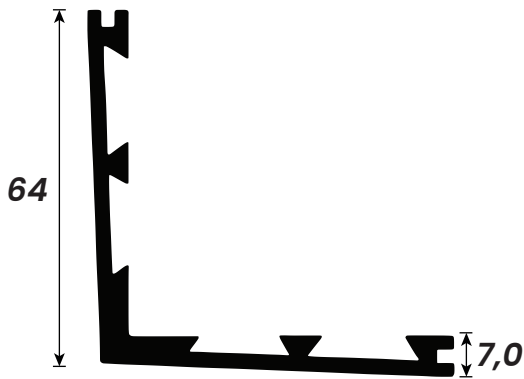

Cod. Poliformas	Peso (kg/m)
CL-044	1,050

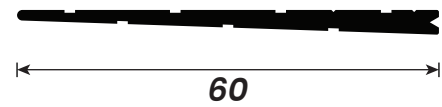

Cod. Poliformas	Peso (kg/m)
CL-010	0,422

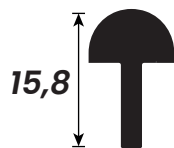

Cod. Poliformas	Peso (kg/m)
AL-02	0,185

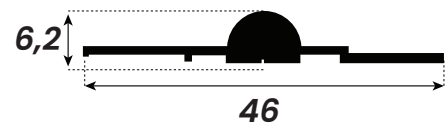

Cod. Poliformas	Peso (kg/m)
AL-20	0,224

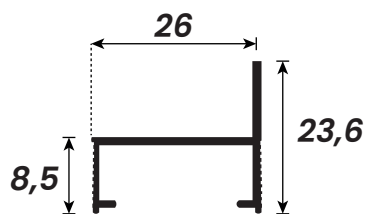

Cod. Poliformas	Peso (kg/m)
CM-200	0,170

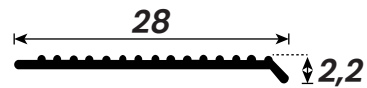

Cod. Poliformas	Peso (kg/m)
ACP-008	0,078

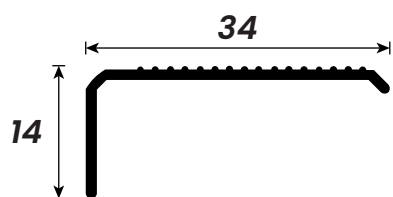

Cod. Poliformas	Peso (kg/m)
ACP-006	0,130

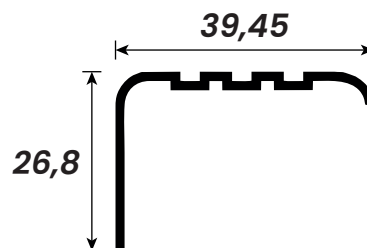

Cod. Poliformas	Peso (kg/m)
ME-013	0,275

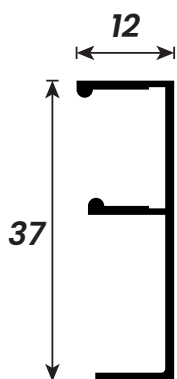

Cod. Poliformas	Peso (kg/m)
MP-347	0,198

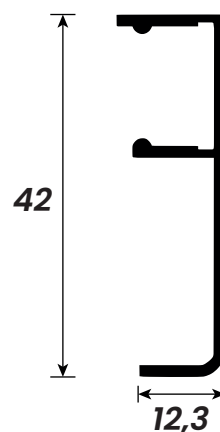

Cod. Poliformas	Peso (kg/m)
MN-014	0,210

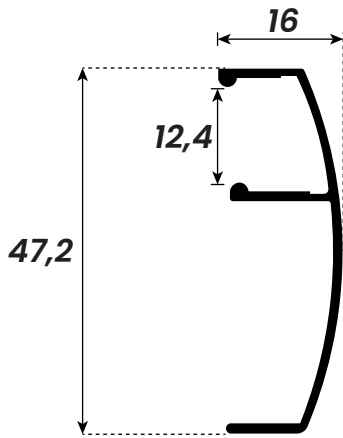

Cod. Poliformas	Peso (kg/m)
MP-4302	0,250

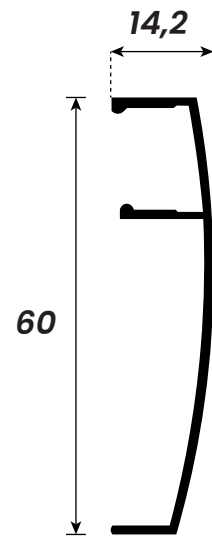

Cod. Poliformas	Peso (kg/m)
MA-050	0,286



Rua C-103, Qd 208, Lt 06 - Setor Sudoeste CEP: 74303-075 - Goiânia - Goiás
(62) 3247 3610
www.poliformas.com.br