

alumínio ALUMÍNIO

MODELO SUPREMA

poliformas 
ALUMÍNIOS E FERRAGENS

CÓDIGO	PESO (kg/m)	DESCRIÇÃO	PÁGINA
SU-001	0,730 kg	Trilho Superior 2 folhas	01
SU-002	0,692 kg	Trilho Inferior 2 folhas	01
SU-003	0,513 kg	Marco Lateral Único 2 folhas	01
SU-004	0,500 kg	Marco da bandeira - peitoril 2 folhas	01
SU-005	1,052 kg	Trilho superior 2 folhas com travessa para bandeira	01
SU-006	1,090 kg	Trilho inferior 2 folhas com travessa para peitoril	01
SU-007	0,380 kg	Marco Lateral Liso 2 folhas	02
SU-008	0,253 kg	Complemento marco lateral janela de correr	02
SU-009	0,926 kg	Coluna	02
SU-010	0,998 kg	Trilho Superior 3 folhas	02
SU-011	0,938 kg	Trilho Inferior 3 folhas	03
SU-012	0,529 kg	Marco lateral liso 3 folhas	03
SU-013	0,725 kg	Marco Lateral Duplo 3 folhas	03
SU-014	0,628 kg	Marco Lateral Único 3 folhas	03
SU-039	0,495 kg	Montante Lateral	05
SU-040	0,451 kg	Montante Mão de Amigo	05
SU-041	0,480 kg	Montante Mão de Amigo escovinha	05
SU-042	0,560 kg	Montante Mão de Amigo Central	05
SU-047	1,048 kg	Montante Mão de Amigo tub. Sem escovinha	04
SU-049	1,052 kg	Montante Mão de Amigo tub. Com escovinha	04
SU-053	0,456 kg	Travessa da Folha	04
SU-055	0,540 kg	Montante Lateral - veneziana	07
SU-056	0,520 kg	Montante Mão de Amigo - veneziana	07
SU-061	1,065 kg	Montante Mão de Amigo tub. veneziana	07
SU-068	0,518 kg	Montante Folha veneziana	08
SU-069	0,575 kg	Montante Mão de Amigo Central - veneziana	08
SU-070	0,520 kg	Montante Mão Amigo escovinha - veneziana	08
SU-079	0,340 kg	Marco Maxim ar	09
SU-080	0,360 kg	Travessa Superior Folha Maxim ar	08
SU-081	0,410 kg	Montante Folha Maxim ar sem escovinha	09
SU-082	0,320 kg	Travessa da folha com olhal maxim ar	09
SU-084	0,125 kg	Pingadeira da folha maxim ar	09
SU-086	0,590 kg	Coluna - Marco Maxim ar	09
SU-102	0,115 kg	Baguete 11 x 12mm	10
SU-103	0,140 kg	Baguete 13,8 x 15mm	10
SU-108	0,138 kg	Complemento para veneziana	10
SU-110	0,535 kg	Travessa da folha - porta	10
SU-111	0,631 kg	Montante da Folha - porta	11
SU-120	0,491 kg	Montante da folha	10
SU-121	1,498 kg	Trilho Superior 4 folhas	04
SU-122	1,440 kg	Trilho Inferior 4 folhas	04
SU-123	0,845 kg	Marco Lateral Liso 4 folhas	04
SU-186	0,505 kg	Travessa da Folha - veneziana	07
SU-188	0,580 kg	Travessa central da folha - veneziana	08
SU-192	0,565 kg	Complemento marco central/correr	08
SU-200	0,445 kg	Montante Folha Maxim ar com escovinha	08
SU-225	0,985 kg	Travessa Inferior da Folha - baguete	06
SU-226	0,980 kg	Travessa Inferior da Folha - veneziana	07
SU-227	0,530 kg	Travessa Central da Folha	06
SU-228	0,675 kg	Trilho Inferior 2 folhas - embutir	02
SU-230	0,965 kg	Trilho Inferior 3 folhas - embutir	03
SU-241	0,700 kg	Montante da folha - veneziana	11
SU-242	0,730 kg	Montante Mão de Amigo escovinha - Porta	05
SU-243	0,700 kg	Montante Mão de Amigo	05
SU-245	0,708 kg	Montante Lateral	06
SU-271	0,358 kg	Trilho inferior para porta	03
SU-276	0,170 kg	Pingadeira Maxim ar	09

CÓDIGO	PESO (kg/m)	DESCRIÇÃO	PÁGINA
SU-279	0,550 kg	Marco Lateral / Porta	10
SU-280	0,998 kg	Montante lateral da folha com puxador	06
SU-289	1,060 kg	Montante mão de amigo 64,8 c/ reforço externo	06
SU-290	1,098 kg	Montante mão de amigo 64,8 c/ reforço externo	06
SU-291	0,258 kg	Complemento Marco Lateral / Correr	02



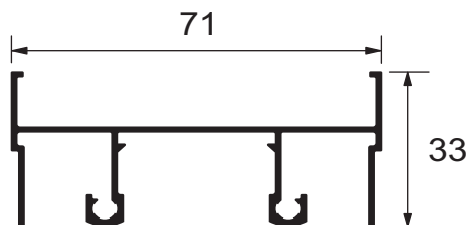

Cód. Poliformas	Peso (kg/m)
SU-001	0,730

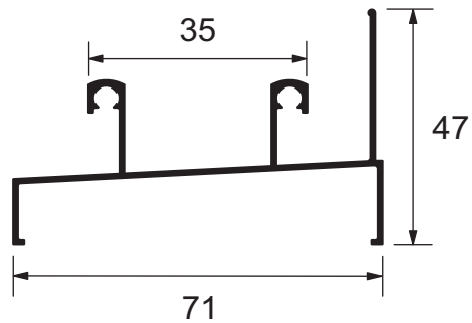

Cód. Poliformas	Peso (kg/m)
SU-002	0,692

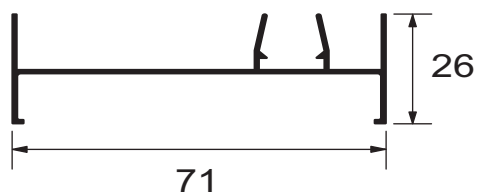

Cód. Poliformas	Peso (kg/m)
SU-003	0,513

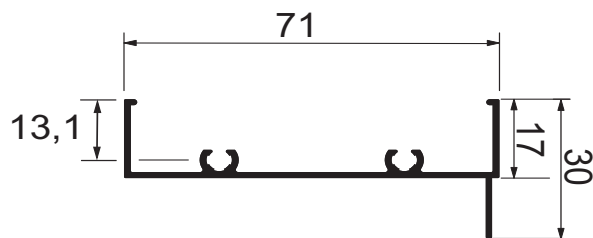

Cód. Poliformas	Peso (kg/m)
SU-004	0,500

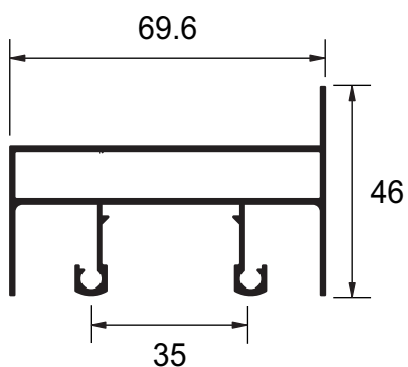

Cód. Poliformas	Peso (kg/m)
SU-005	1,052

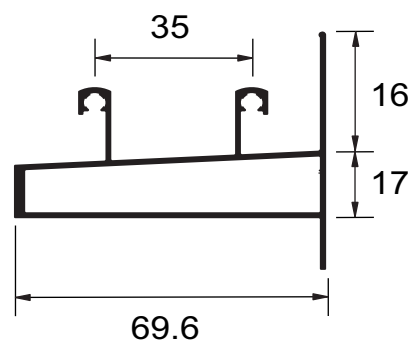

Cód. Poliformas	Peso (kg/m)
SU-006	1,090

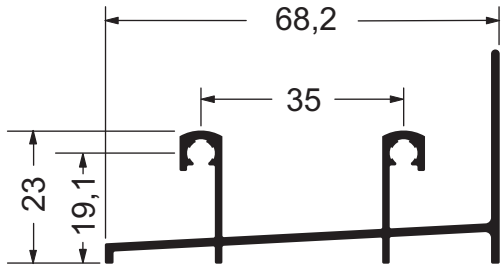

Cód. Poliformas	Peso (kg/m)
SU-228	0,675



Cód. Poliformas	Peso (kg/m)
SU-007	0,380

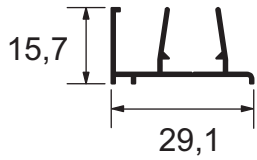

Cód. Poliformas	Peso (kg/m)
SU-008	0,253

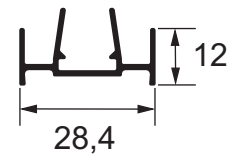

Cód. Poliformas	Peso (kg/m)
SU-291	0,258

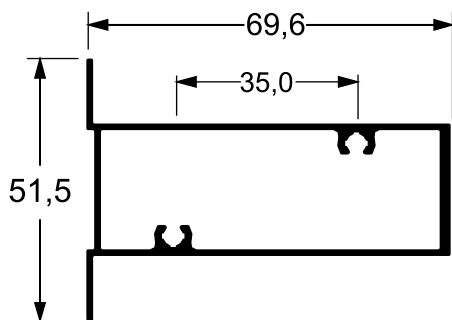

Cód. Poliformas	Peso (kg/m)
SU-009	0,926

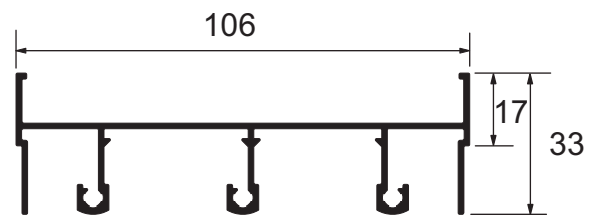

Cód. Poliformas	Peso (kg/m)
SU-010	0,998

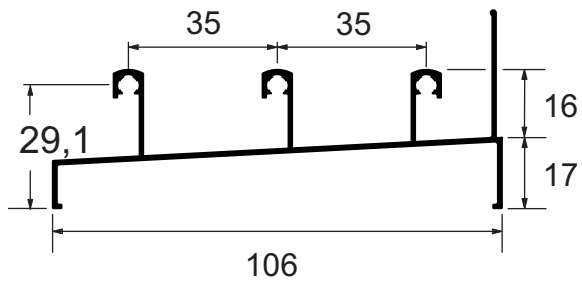

Cód. Poliformas	Peso (kg/m)
SU-011	0,938

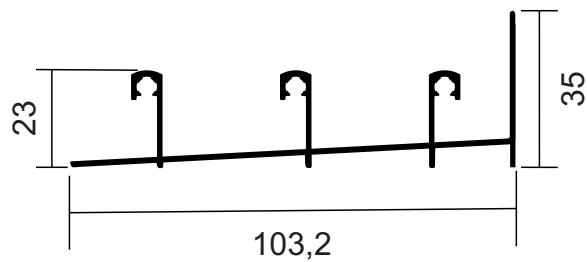

Cód. Poliformas	Peso (kg/m)
SU-230	0,965

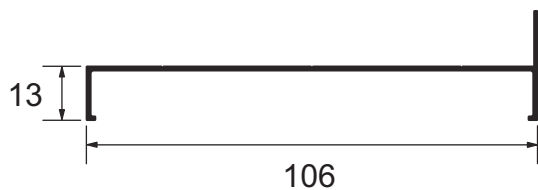

Cód. Poliformas	Peso (kg/m)
SU-012	0,529

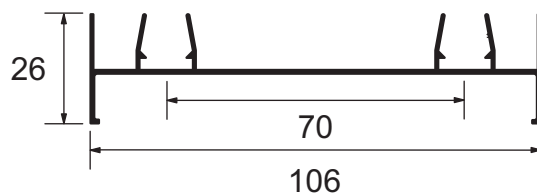

Cód. Poliformas	Peso (kg/m)
SU-013	0,725

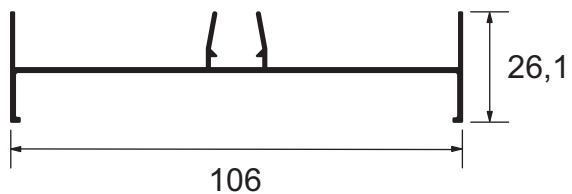

Cód. Poliformas	Peso (kg/m)
SU-014	0,628

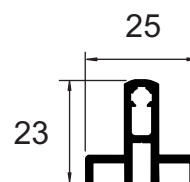

Cód. Poliformas	Peso (kg/m)
SU-271	0,358

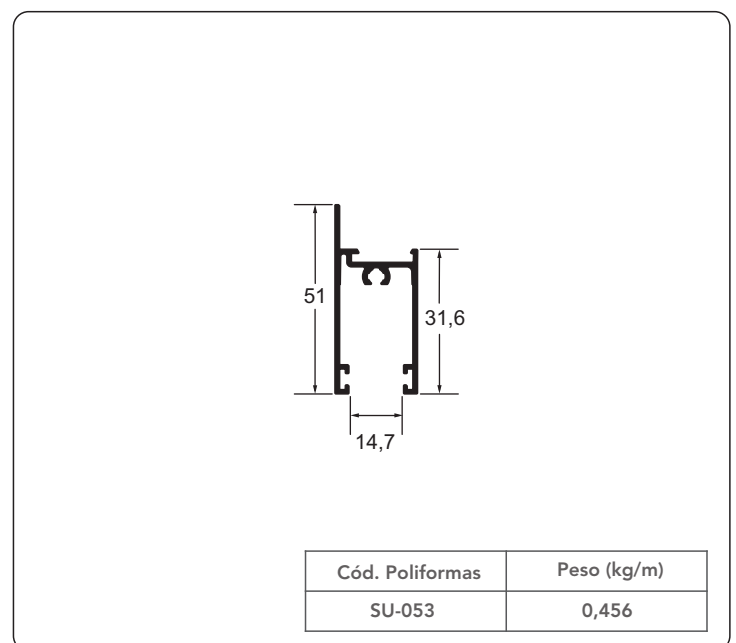
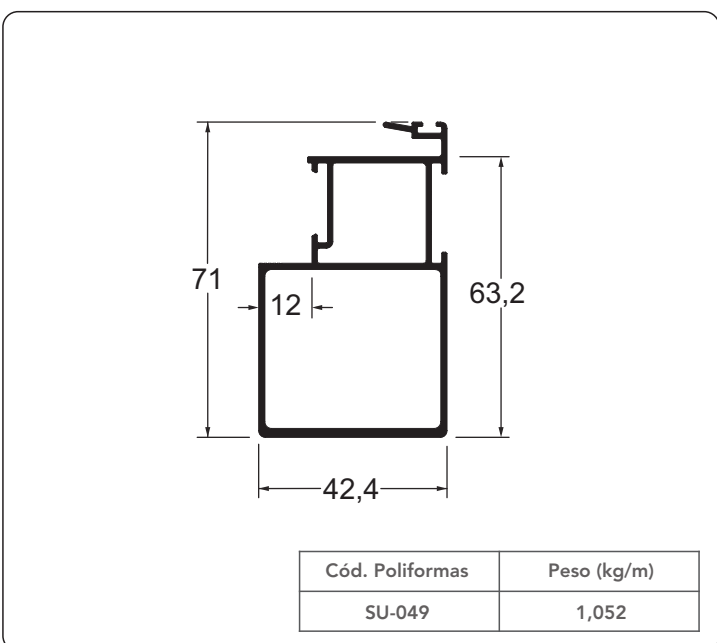
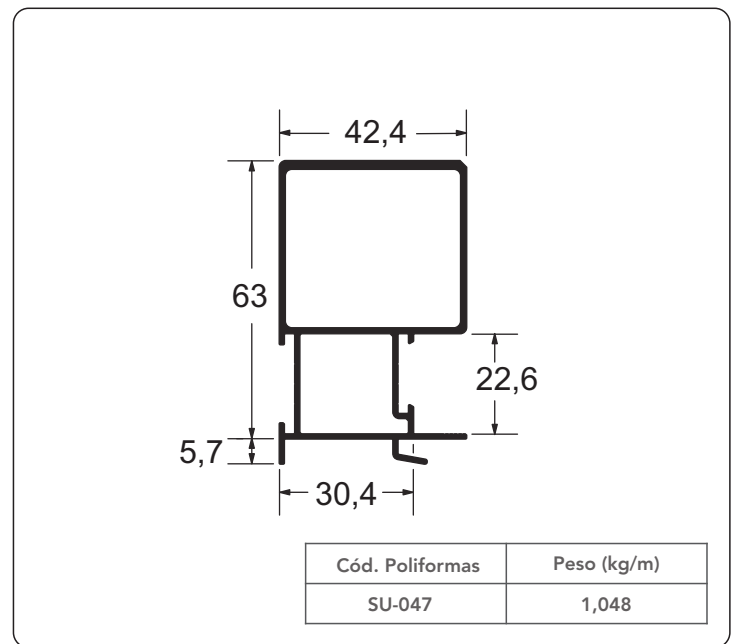
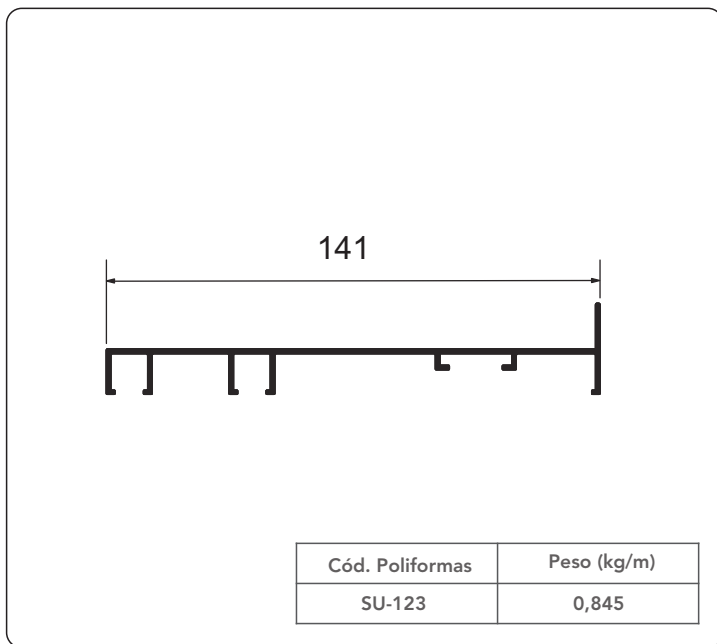
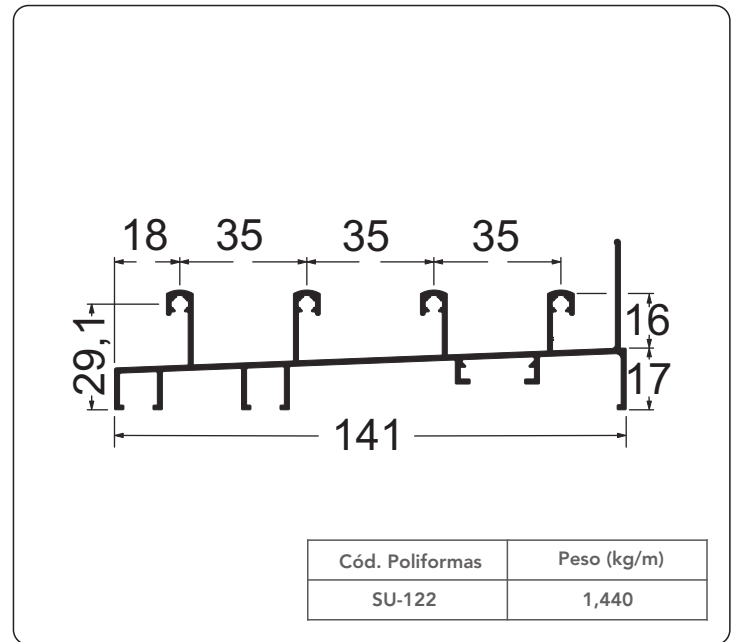
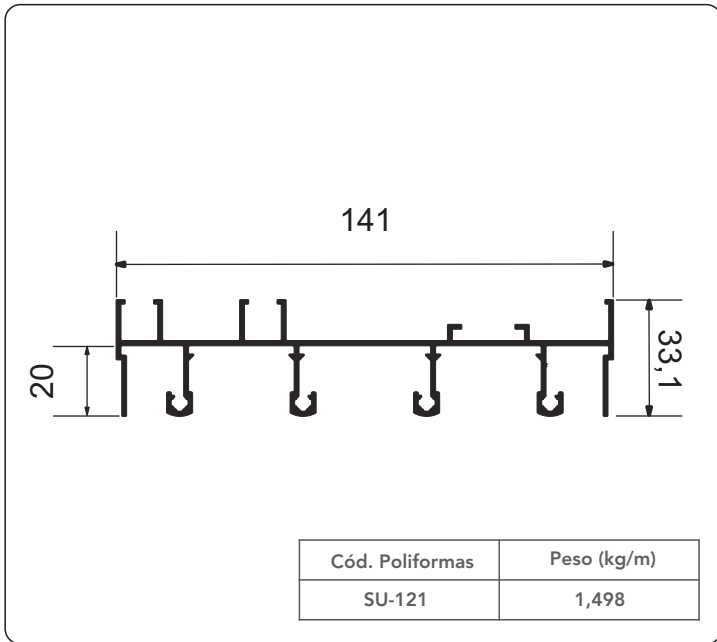

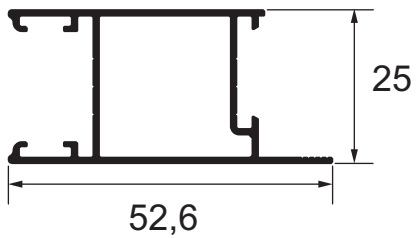

Cód. Poliformas	Peso (kg/m)
SU-039	0,495

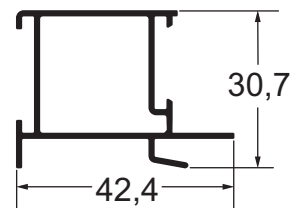

Cód. Poliformas	Peso (kg/m)
SU-040	0,451

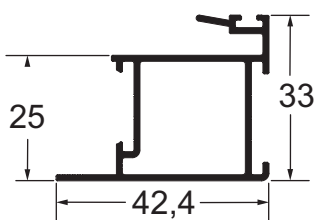

Cód. Poliformas	Peso (kg/m)
SU-041	0,480

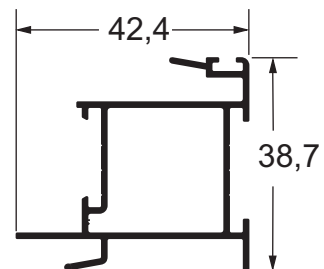

Cód. Poliformas	Peso (kg/m)
SU-042	0,560

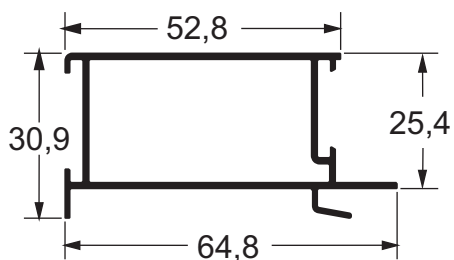

Cód. Poliformas	Peso (kg/m)
SU-243	0,700

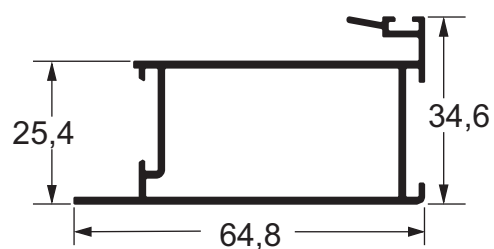

Cód. Poliformas	Peso (kg/m)
SU-242	0,730

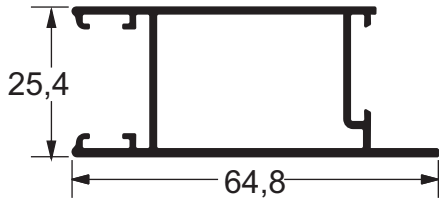

Cód. Poliformas	Peso (kg/m)
SU-245	0,708

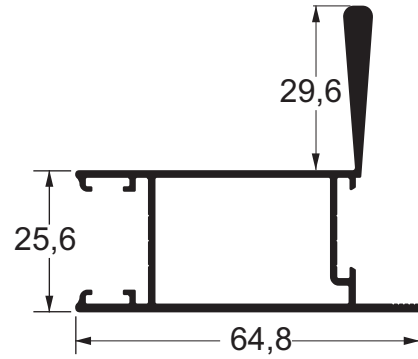

Cód. Poliformas	Peso (kg/m)
SU-280	0,998

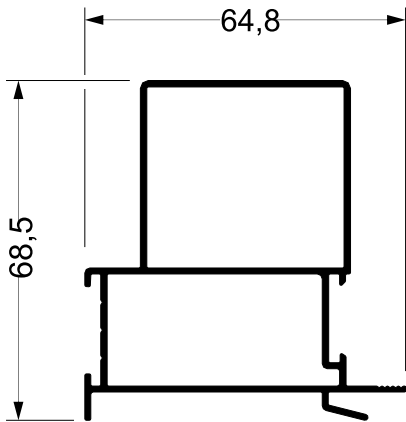

Cód. Poliformas	Peso (kg/m)
SU-289	1,060

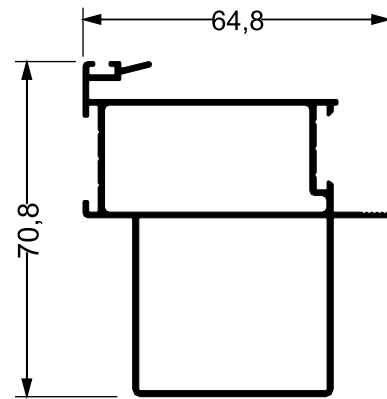

Cód. Poliformas	Peso (kg/m)
SU-290	1,098

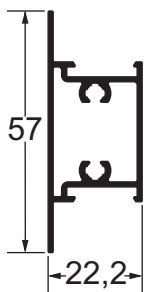

Cód. Poliformas	Peso (kg/m)
SU-227	0,530

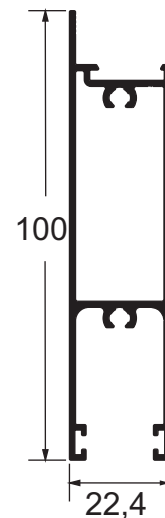

Cód. Poliformas	Peso (kg/m)
SU-225	0,985

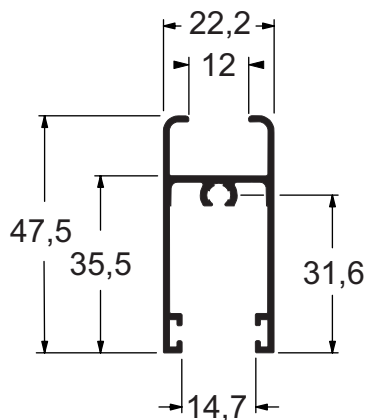

Cód. Poliformas	Peso (kg/m)
SU-186	0,505

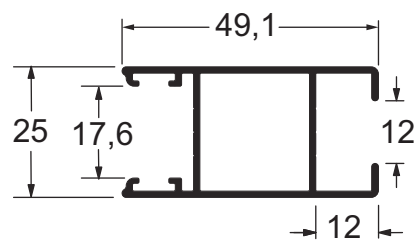

Cód. Poliformas	Peso (kg/m)
SU-055	0,540

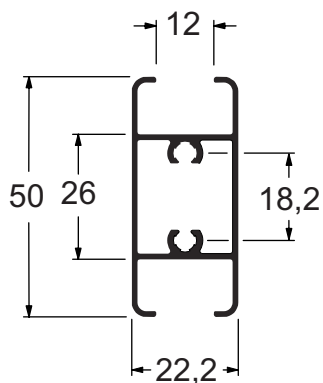

Cód. Poliformas	Peso (kg/m)
SU-188	0,580

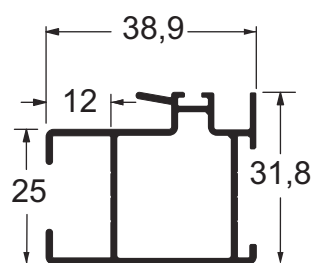

Cód. Poliformas	Peso (kg/m)
SU-056	0,520

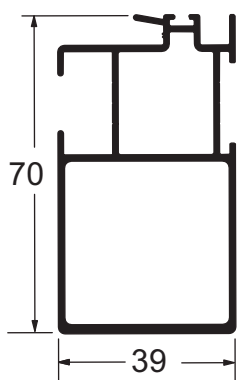

Cód. Poliformas	Peso (kg/m)
SU-061	1,065

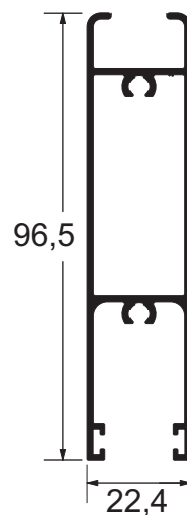

Cód. Poliformas	Peso (kg/m)
SU-226	0,980

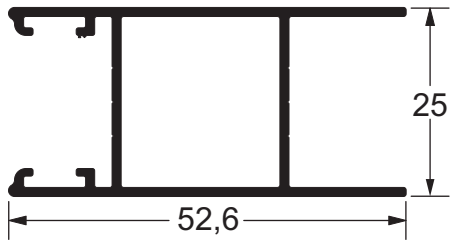

Cód. Poliformas	Peso (kg/m)
SU-068	0,518

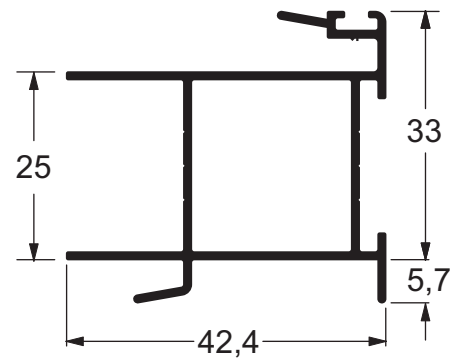

Cód. Poliformas	Peso (kg/m)
SU-069	0,575

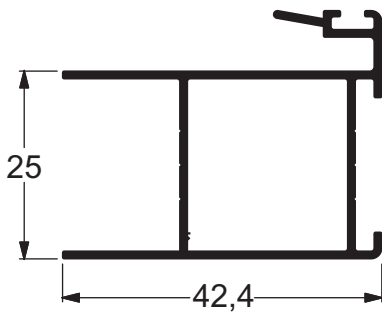

Cód. Poliformas	Peso (kg/m)
SU-070	0,520

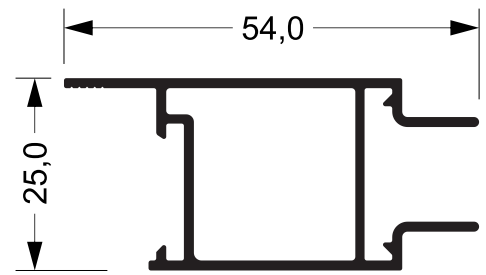

Cód. Poliformas	Peso (kg/m)
SU-192	0,565

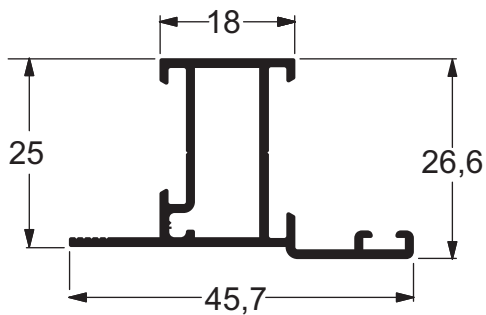

Cód. Poliformas	Peso (kg/m)
SU-200	0,445

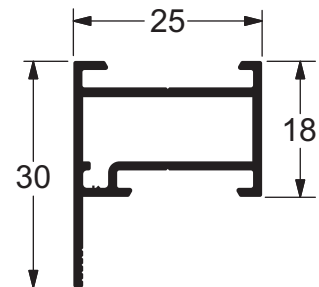

Cód. Poliformas	Peso (kg/m)
SU-080	0,360

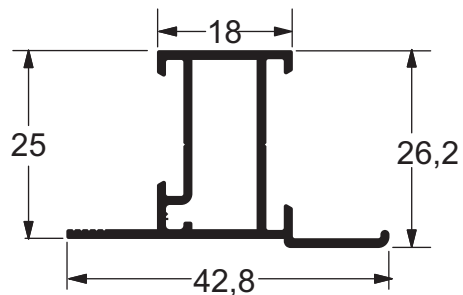

Cód. Poliformas	Peso (kg/m)
SU-081	0,410

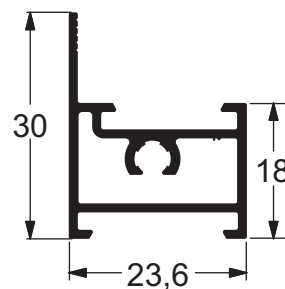

Cód. Poliformas	Peso (kg/m)
SU-082	0,320

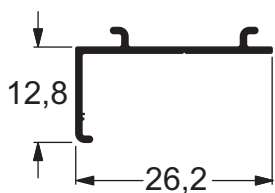

Cód. Poliformas	Peso (kg/m)
SU-084	0,125

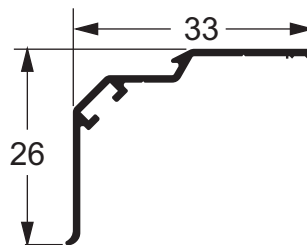

Cód. Poliformas	Peso (kg/m)
SU-276	0,170

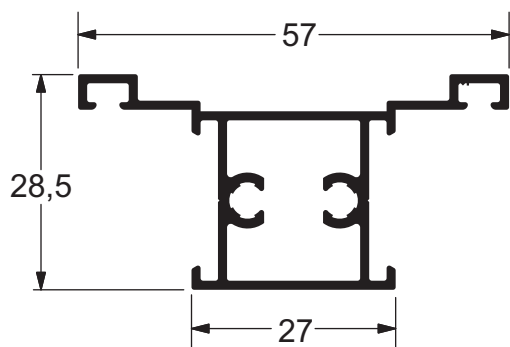

Cód. Poliformas	Peso (kg/m)
SU-086	0,590

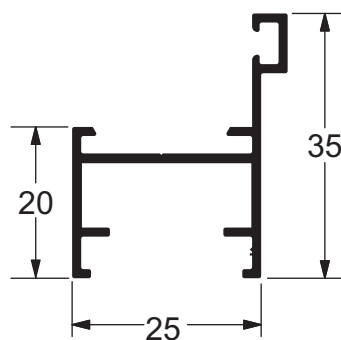

Cód. Poliformas	Peso (kg/m)
SU-079	0,340

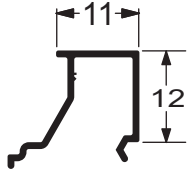

Cód. Poliformas	Peso (kg/m)
SU-102	0,115

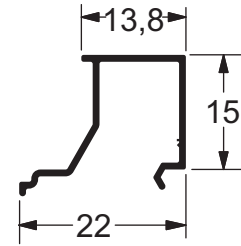

Cód. Poliformas	Peso (kg/m)
SU-103	0,140

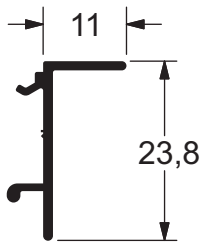

Cód. Poliformas	Peso (kg/m)
SU-108	0,138

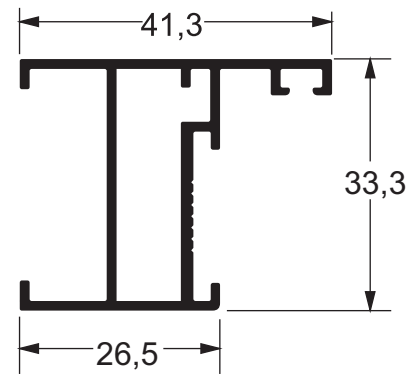

Cód. Poliformas	Peso (kg/m)
SU-279	0,550

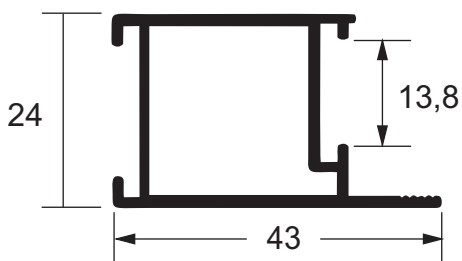

Cód. Poliformas	Peso (kg/m)
SU-120	0,491

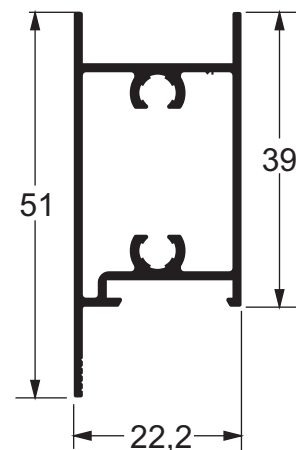

Cód. Poliformas	Peso (kg/m)
SU-110	0,535

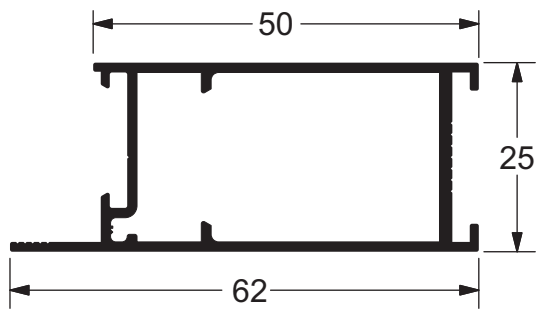

Cód. Poliformas	Peso (kg/m)
SU-111	0,631

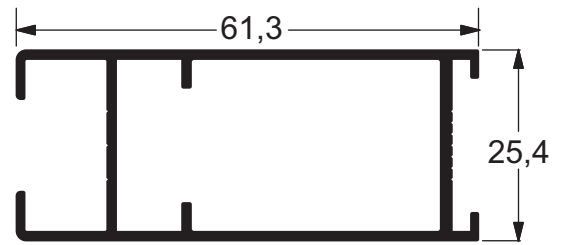

Cód. Poliformas	Peso (kg/m)
SU-241	0,700



Rua C-103, Qd 208, Lt 06 - Setor Sudoeste CEP: 74303-075 - Goiânia - Goiás
(62) 3247 3610
www.poliformas.com.br